



RHINO-RACK®

Weatherproof Luggage Bag LB200, LB250, LB350, LB500, LB600

Important:

1. Check the Rhino-Rack website to ensure you have the latest issue of these instructions.
2. Please refer to your fitting instruction to ensure that the accessory is installed in the correctly.
3. Check the contents of kit before commencing fitment and report any discrepancies.
4. Place these instructions in the vehicle's glove box after installation is complete.
5. These instructions must be followed for warranty to be upheld.

Fit Time: 10 min



Rhino-Rack AUSTRALIA
22A Hanson Pl,
Eastern Creek, NSW, 2766
(02) 8846 1900
rhinorack.com.au

Rhino-Rack USA
Unit D, 2450 Airport Blvd,
Aurora, CO, 80011
877-744-6622
rhinorack.com

Document No: R1235
Issue No: 03
Issue Date: 18/01/2021

LB200, LB250, LB350, LB500, LB600 Instructions

Carrying Capacity

Check the **vehicle owners hand book** for your vehicle manufacturer's maximum carrying capacity. Do not exceed the vehicle manufacturer's maximum roof carrying capacity. The weight of the roof racks and additional accessories, must also be included in the total vehicle roof load.

Ensure that all loads are evenly distributed and that the centre of gravity is kept as low as possible.

Warning

- Do not attempt to fit the accessory to your vehicle unless you fully understand these fitting instructions. Please direct any questions regarding fitting to the dealer from where the product was purchased.
- Off-road conditions can be much more rigorous. Extreme care must be taken in off road conditions.
- Always ensure you fasten your load securely so that the Luggage Bag contents cannot move about while the car is moving. Only use non-stretch fastening ropes or straps.
- **The Luggage Bag is only to be mounted onto a Rhino Pioneer Platform/Tray or Rhino Roof Basket, NOT directly to the crossbars or directly onto the vehicle roof.**
- **The Luggage Bag is designed to carry light bulky items only.** Do NOT use it to carry heavy items such as a BBQ gas bottle, spare wheel, or high lift vehicle jack etc.
- **Any sharp / pointed items in your Luggage Bag should be properly wrapped and secured to avoid puncturing the product.**
- Wash the Luggage Bag with a non petroleum based detergent such as dishwashing liquid or car wash. Never use a scourer or wire brush on the Luggage Bag. Accessory must be removed when vehicle is put through an automatic car wash.
- Ensure the Luggage Bag flaps are sealed properly the whole way around, to minimise the chance of water and dust entering. (see Page 3, Step 4)

In service maintenance checks

- All bolted connections should be checked after driving a short distance when you first install your roof racks & accessories.
- All bolted connections should be checked again at regular intervals (every 1000k (621mi) is recommended, depending on road conditions, usage, loads and distances travelled). All bolted connections should be checked each time they are re-fitted.

Torque Settings:

Unless stated otherwise in these instructions, all fasteners should be set to the following torque settings:

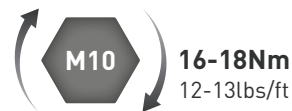

Sensitivity to Crosswinds, Behaviour in Curves and Braking.

Remember that the handling characteristics of your vehicle will change when transporting a load on the roof.

Exercise extreme care when transporting wind-resisting loads; special consideration must be taken into account when braking.

Note for Dealers and Fitters

It is your responsibility to ensure these fitting instructions are given to the end user or client. These instructions remain the property of Rhino-Rack Australia Pty. Ltd. and may not be used or changed for any other purpose than intended.

Parts List

Luggage Bag

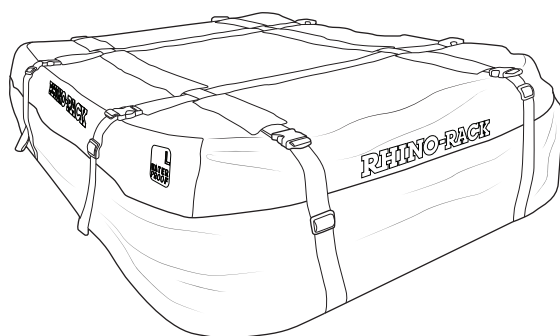

Luggage Bag Sizes:

- (LB200) Half
- (LB250) Small
- (LB350) Medium
- (LB500) Large
- (LB600) Extra Large

A x1

1



FRONT OF VEHICLE

NOTE: All bag sizes follow the same installation process. An Extra Large Bag (LB600) is shown in this instruction.

2

Unclip the buckles on all sides of the bag. Number of clips will vary depending on bag size.

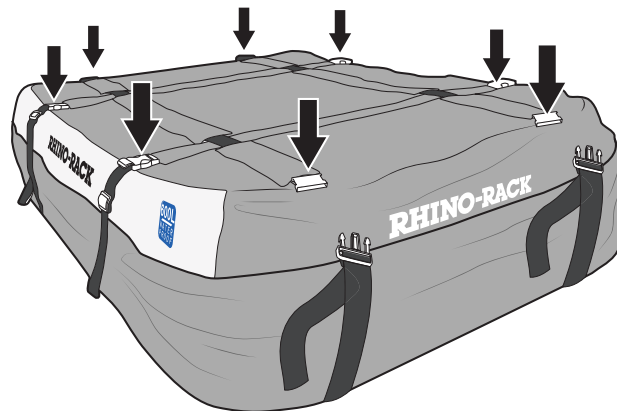

3

To open the bag, locate the zipper near the **FRONT**. Unzip around the rear of the bag and bring to the opposite side of where the process was started.

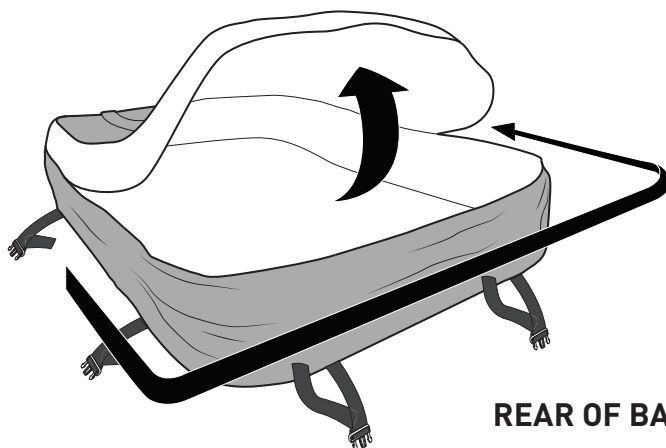

REAR OF BAG

The bag opens around the **REAR**.

This is deliberate to ensure it cannot open from oncoming wind if the straps are mistakenly left undone.

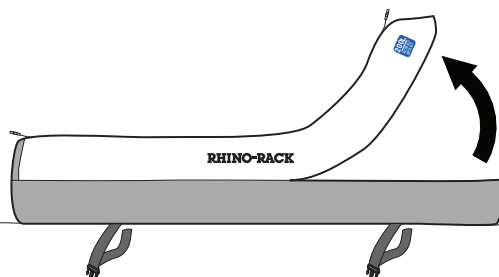

REAR OF BAG

4

When the bag has been packed, re-zip the bag shut. **Evenly spread the load** to be carried to reduce bulging.



SIDE VIEW:

Ensure the outer lip extends over the inner lip and zipper of the bag.

This will ensure water cannot penetrate the zipper.

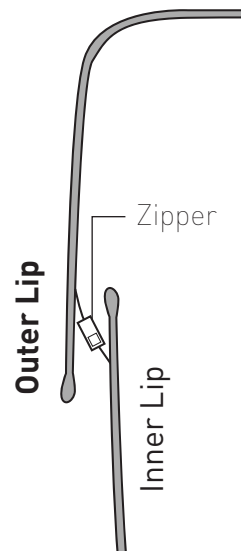

- 5** Re-clip the straps, and pull the straps taunt to secure load in place.



Pull the straps taunt.
Ensure not to overtighten and damage the webbing.

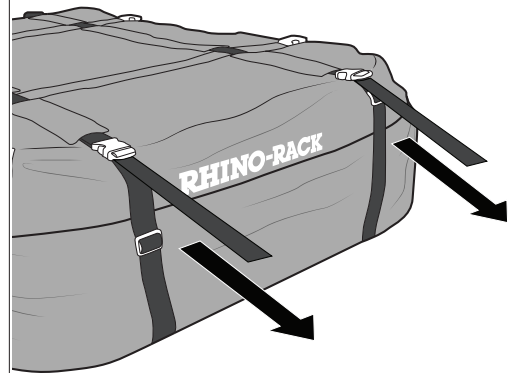

6

FOR PIONEER PLATFORM / TRAY FITMENT:

1. Place the Luggage Bag onto the Platform with the bag opening facing the **REAR** of the vehicle.
2. Secure the bag to the Platform by threading the external straps under the longitudinal planks.
3. Snap the plastic clips together.
4. Pull the straps to put tension on the load.

Note: Additional straps should be used to secure odd shaped loads.

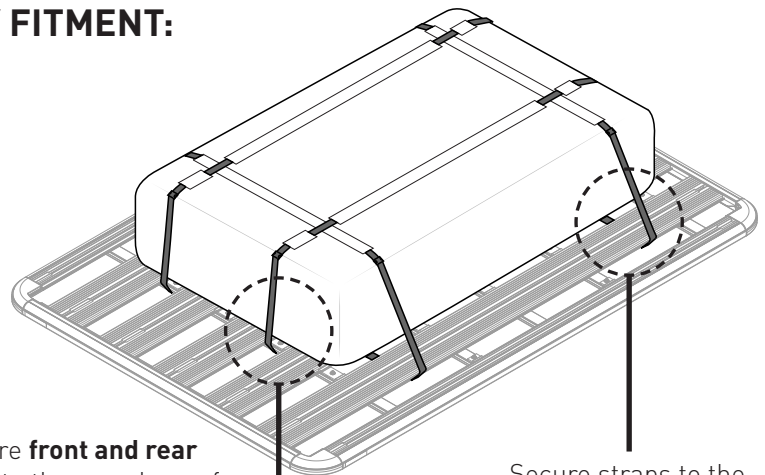

Secure **front and rear straps** to the crossbars of the Platform / Tray.

Secure straps to the **longitudinal planks**.

FOR ROOF BASKET FITMENT:

1. Place the Luggage Bag onto the Roof Basket with the bag opening facing the **REAR** of the vehicle.
2. Secure the bag to the basket by threading the external straps through the basket and around the outer rim of the basket.
3. Snap the plastic clips together.
4. Pull the straps to put tension on the load.

Note: Additional straps should be used to secure odd shaped loads.

SIDE VIEW:

Wrap the strap around the outside of the basket

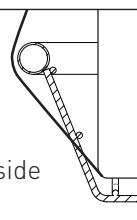

Secure the straps **around the rim** of the basket.