

AMP RESEARCH **BedXTender HD™**

MADE IN USA

APPLICATION

GM Truck (Full-size Trucks)

PART #

74805-00A (Silver)

74805-01A(Black)

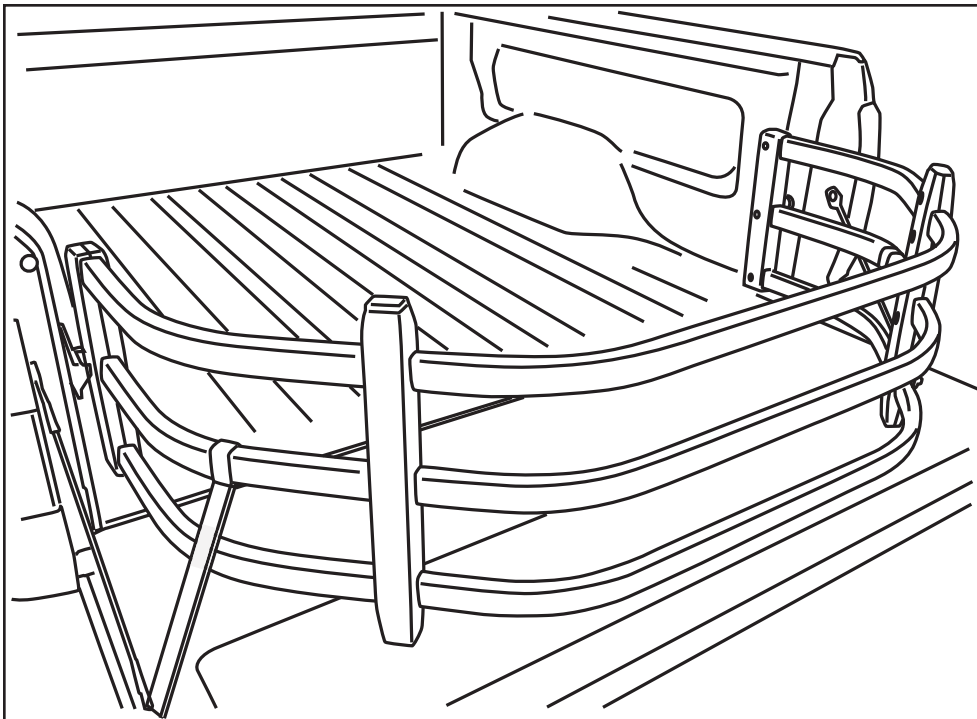

BEDXTENDER HD™ shown assembled and installed on truck.

Remove contents from box and check for damage.

Verify all parts against parts list.

Read and understand instructions completely before attempting assembly and installation.

INSTALLATION TIME
1 Hour

SKILL LEVEL



1= Easy

TOOLS REQUIRED

Phillips screw driver

Torx T-25 driver

Power drill

1/8" drill bit

21/64" drill bit

Center punch

Supplied templates

Soapy Water

WARRANTY

3-Year Limited Warranty

Invented, engineered and manufactured exclusively by AMP Research in the USA. May be covered by one of the following patents:

5,700,047; 6,113,173; 6,402,215; 6,805,392; 7,063,366; 7,393,035; 7,654,598; 7,681,935; 7,841,638

PARTS LIST AND HARDWARE IDENTIFICATION

1 x2
Quick Mount
Bracket Set

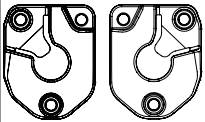

2 x2
Mounting Bracket

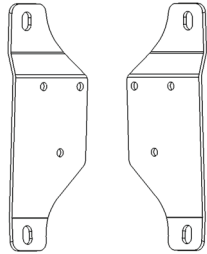

3 x12
PT-Screw

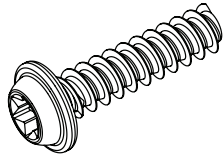

4 x4
Bumper

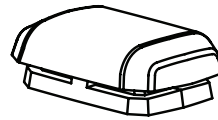

5 x2
Strap Buckle Assembly

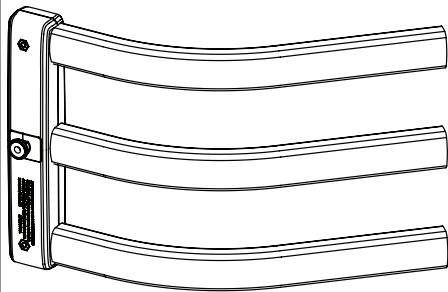

6 x2
Pivot Upright Assembly



7 x2
Bumper Upright Outer



8 x2
Bumper Upright Inner

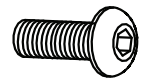

9 x6
M5 Bolt



10 x6
M5 Nut

11
Silver:
Black:
Double Bend Center Tube (With AMP Logo)



12 x4
M8 Bolt



13 x4
M8 Nut

14 x2
Silver:
Black:
Double Bend Center Tube (Without AMP Logo)



AMP RESEARCH BEDXTENDER HD™

MOUNTING BRACKET INSTALLATION - CHEVROLET SILVERADO / GMC SIERRA 2007+

PLEASE READ ENTIRE INSTRUCTIONS BEFORE PROCEEDING WITH INSTALLATION

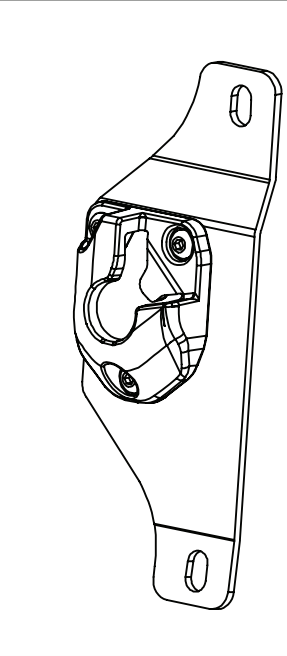
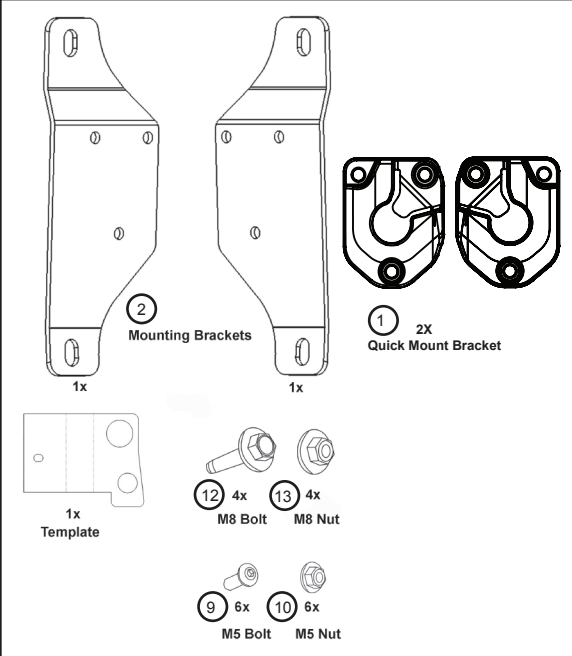

Use the M5 bolts and nuts to fasten the Quick Mount Bracket to the mounting bracket. Apply thread locker to the tip of the M5 bolt. Torque to 8 ft. lbs. Allow 10 minutes to dry before handling. (Passenger side shown)

NOTE: Angle brackets may already be installed onto brackets.

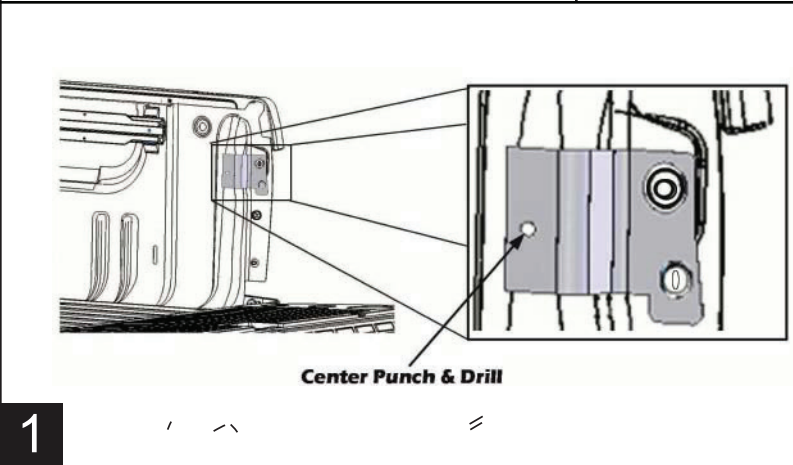

Remove the 2 Phillips screws that are holding the tail lights in place. Carefully pull back to remove tail lights.

Tape template to vehicle to locate upper hole of Mounting Bracket. Mark (Center Punch) & drill hole with 1/8" drill bit. Remove template and drill out hole with 21/64" drill bit. Use file to remove burrs. Apply primer to edge of hole. Repeat for other side.

1

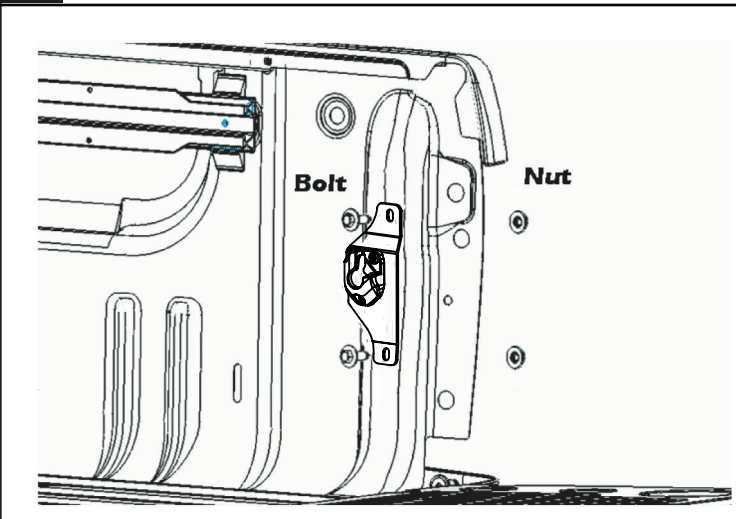

Place Mounting Bracket aligned with top hole. Allow bracket to hang vertically. Mark (Center Punch) location of lower hole using the bracket slot as a template. Remove bracket. Drill hole with 1/8" drill bit then drill out hole with 21/64" drill bit. Use file to remove burrs. Apply primer to edge of hole. Allow primer to dry.

Assemble Mounting Bracket using the M8 bolts & nuts as shown. Tighten & torque to 22ft. lbs. Replace the tail light assembly. Repeat for other side.

2

BED X-TENDER ASSEMBLY

Using template measure 7" from each end of the three long tubes and mark with tape. **Tape is to be**

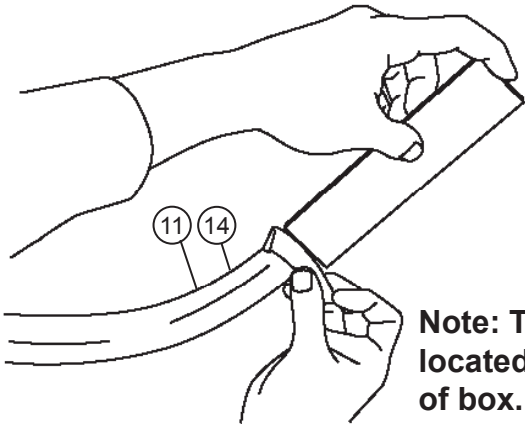

Note: Template located on inside of box.

Slide the center tube (With Amp logo) into the center tube of the 3-tube assembly. **Be sure to slide on Strap Buckle Assembly to center tube of Pivot Upright Assembly**

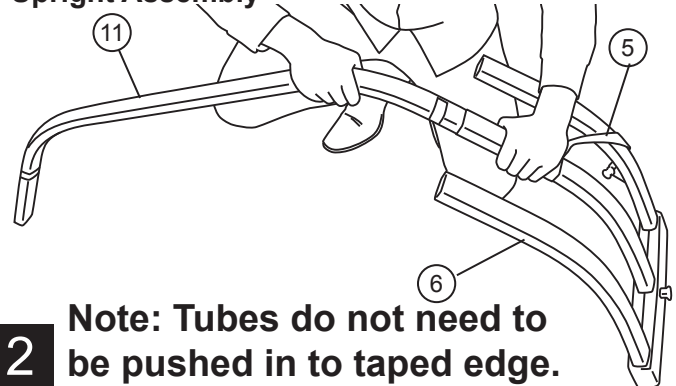

2 Note: Tubes do not need to be pushed in to taped edge.

Insert the top long tube into the top tube of the 3-tube assembly.

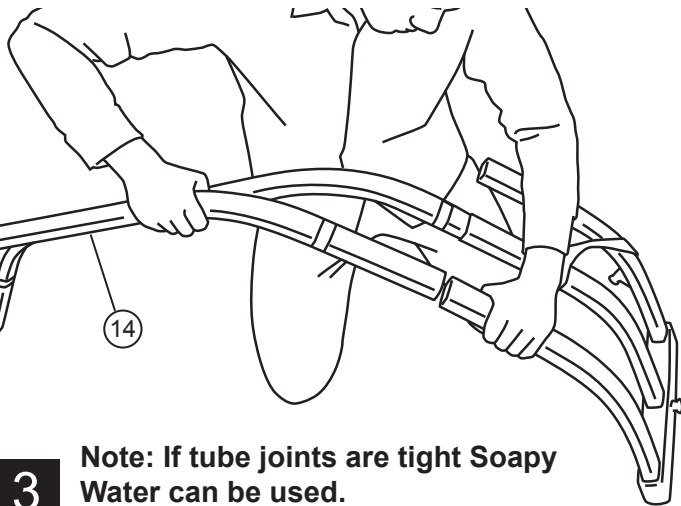

3 Note: If tube joints are tight Soapy Water can be used.

Insert the bottom long tube into the bottom tube of the 3-tube assembly.

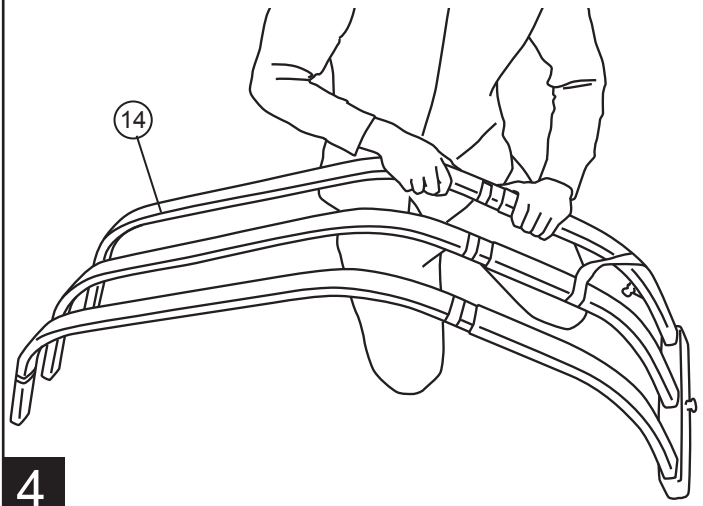

4

Repeat for the other side.

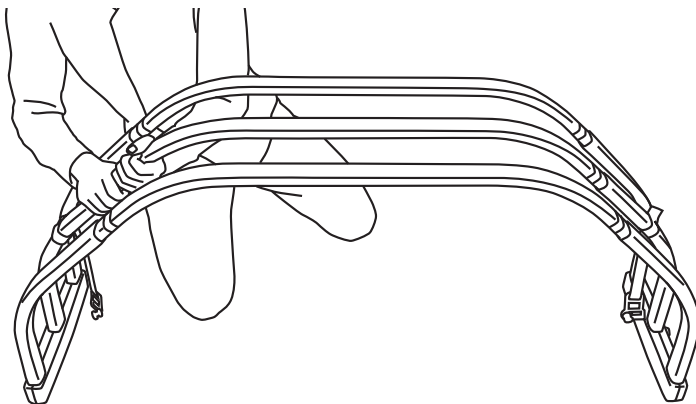

5 Note: Install Strap Buckle Assembly to center tube of Pivot Upright Assembly.

Adjust the width of the BEDXTENDER to fit the pre-installed mounting brackets. To keep tube overlap constant, adjust each tube so that the gap between the edge and the tape is the same.

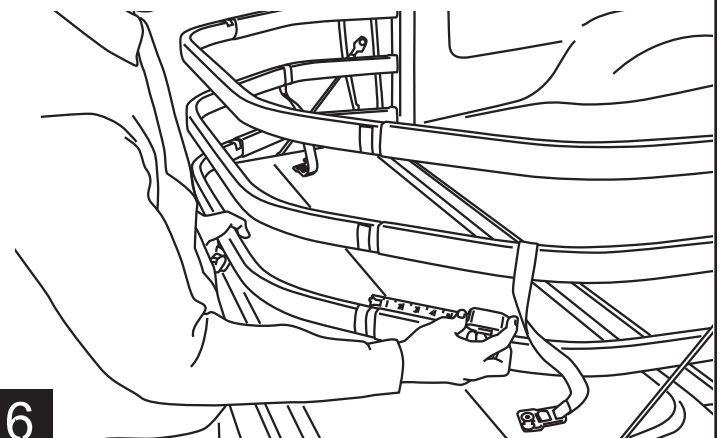

6

BED X-TENDER ASSEMBLY – CONTINUED

Attach plastic upright around the tube juncture, placing rubber bumpers into the two ends of the upright.

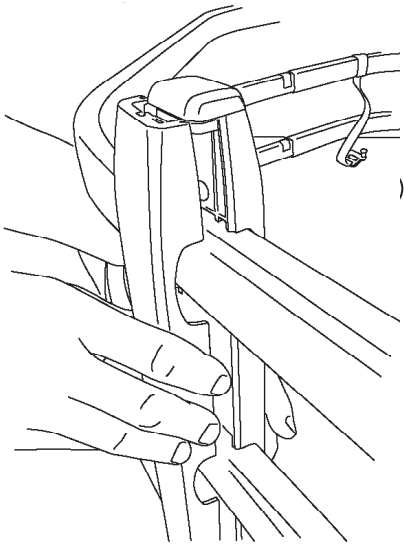

Upright is not positioned in center of tube joint.

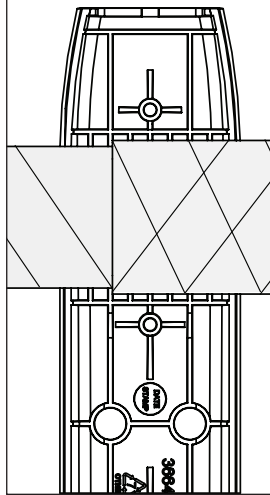

7 NOTE: The inside of the upright is stepped to fit correctly around the small and large diameter tubes.

Tighten PT-Screws using a T-25 torx driver, starting in the middle of each upright, then the outer screws and lastly the remaining two to evenly tighten.

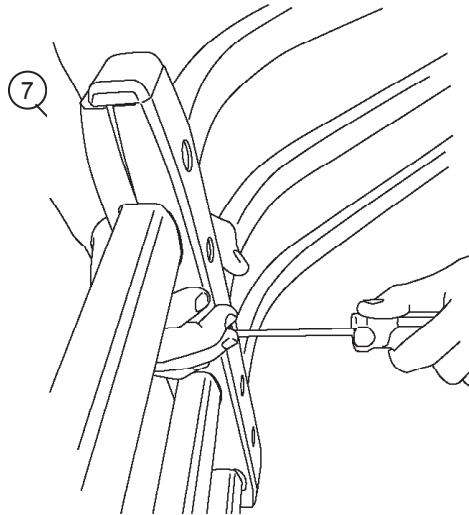

8 NOTE: Do not over tighten as this may strip out. Fastener will reach a noticeable stopping point.

Adjust Strap Buckles to lock into the tailgate when BEDXTENDER is deployed. Your assembly is now complete.

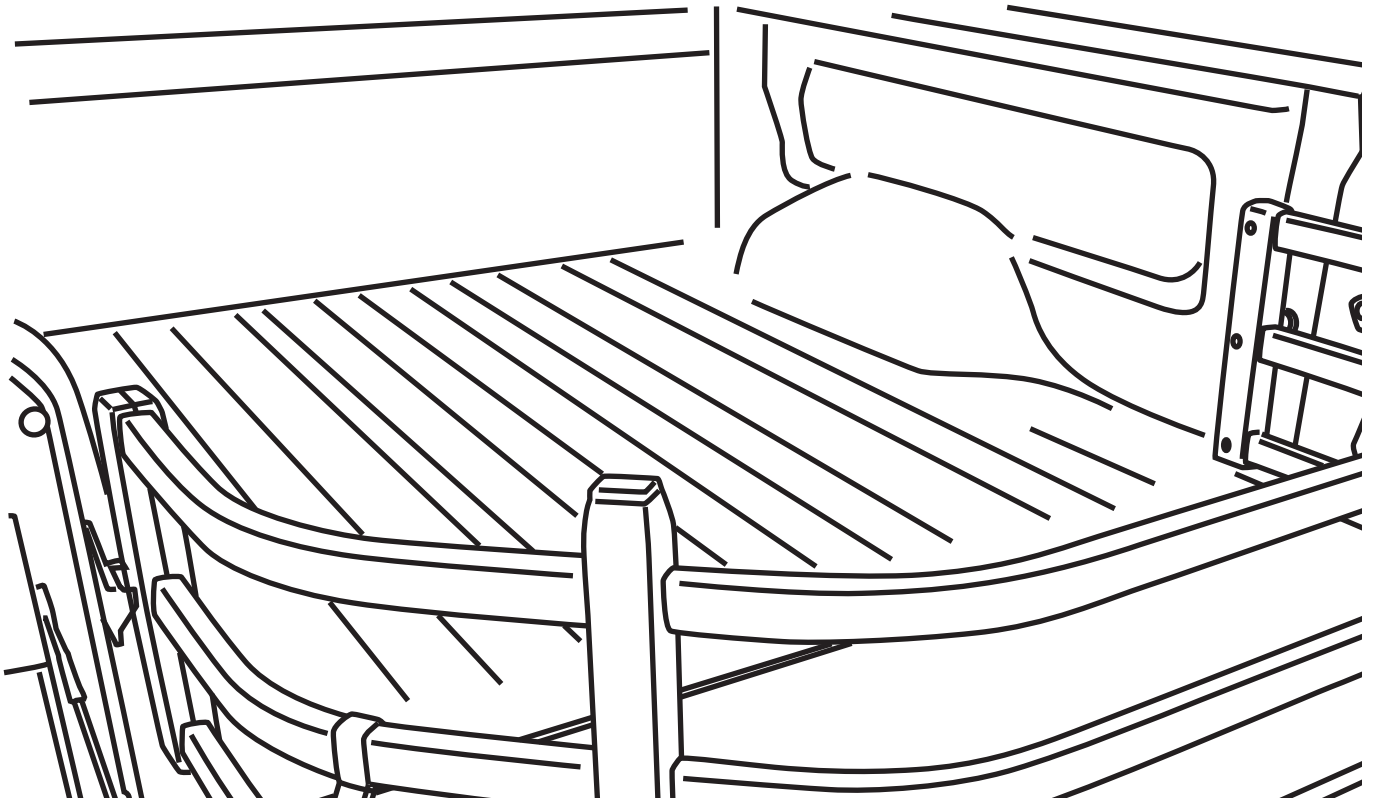

9

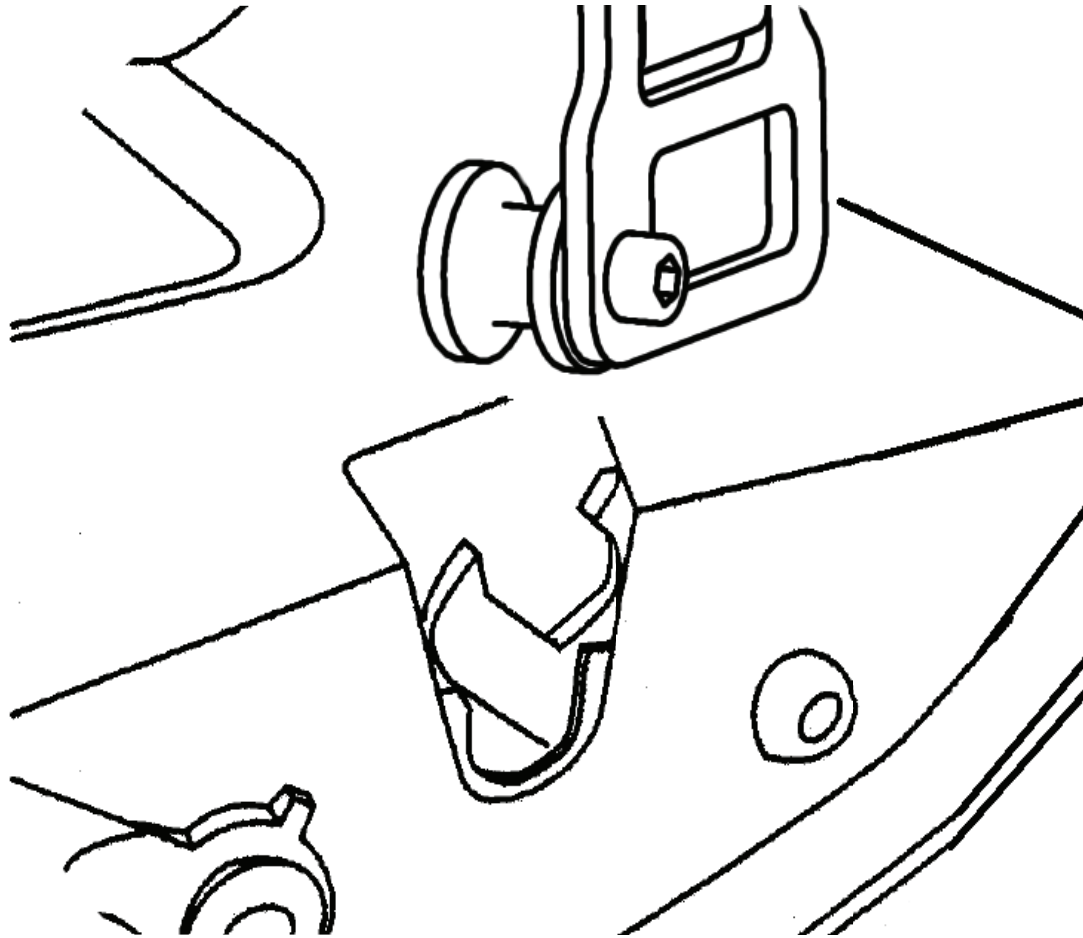

When the BEDXTENDER is at the furthest rear position, push down on the buckle to insert into tailgate latch. Tighten straps. To release, pull tailgate handle.



BEDXTENDER HD™ OPERATION

With the tailgate open, place BEDXTENDER pivot pins into the left and right mounting brackets. Rotate to 45 until it drops into place, then lower onto the open tailgate.



Flip BEDXTENDER out to contain cargo in the truck bed when the tailgate is open. CAUTION! 200lb maximum load on open tailgate. Always distribute cargo evenly and properly secure inside bed. Do not secure cargo to the BEDXTENDER or the tailgate.



Before driving, secure BEDXTENDER by locking the provided strap buckles into the truck's tailgate latches. To release, pull tailgate handle. NOTE: Ensure that both buckles are properly locked into the latches by pulling up on each strap.



Flip BEDXTENDER forward and close the tailgate to keep smaller cargo safe and organized.

AMP RESEARCH LIMITED WARRANTY

AMP RESEARCH warrants this product to be free from defects in material and workmanship for THREE (3) YEARS FROM DATE OF PURCHASE, provided there has been normal use and proper maintenance. This warranty applies to the original purchaser only. All remedies under this warranty are limited to the repair replacement of the product itself, or the repair or replacement of any component part thereof, found by the factory to be defective within the time period specified. The decision to repair or replace is wholly within the discretion of the manufacturer.

This warranty specifically excludes labor. If you have a warranty claim, first you must call our factory at the number below for instructions. You must retain proof of purchase and submit a copy with any items returned for warranty work. Upon completion of warranty work, if any, we will return the repaired or replaced item or items to you freight prepaid. Damage to our products caused by accidents, fire, vandalism, negligence, misinstallation, misuse, Acts of God, or by defective parts not manufactured by us, is not covered under this warranty.

ANY IMPLIED WARRANTIES OF MERCHANTABILITY AND/OR FITNESS FOR A PARTICULAR PURPOSE CREATED HEREBY ARE LIMITED IN DURATION TO THE SAME DURATION AND SCOPE AS THE EXPRESS WRITTEN WARRANTY. OUR COMPANY SHALL NOT BE LIABLE FOR ANY INCIDENTAL OR CONSEQUENTIAL DAMAGE.

Some states do not allow limitations on how long an implied warranty lasts, or the exclusion or limitation of incidental or consequential damages, so the above limitations or exclusions may not apply to you. This warranty gives you specific legal rights, and you may also have other rights that vary from state to state.

FOR WARRANTY ISSUES WITH THIS PRODUCT PLEASE CALL AMP RESEARCH CUSTOMER SERVICE 1-888-983-2204

WARNING

Be sure to read and precisely follow the provided instructions when installing this product. Failure to do so could place the vehicle occupants in a potentially dangerous situation. After installing or reinstalling, re-check to insure that the product is properly installed.